

PostGIS Replication

FOSS4G 2011

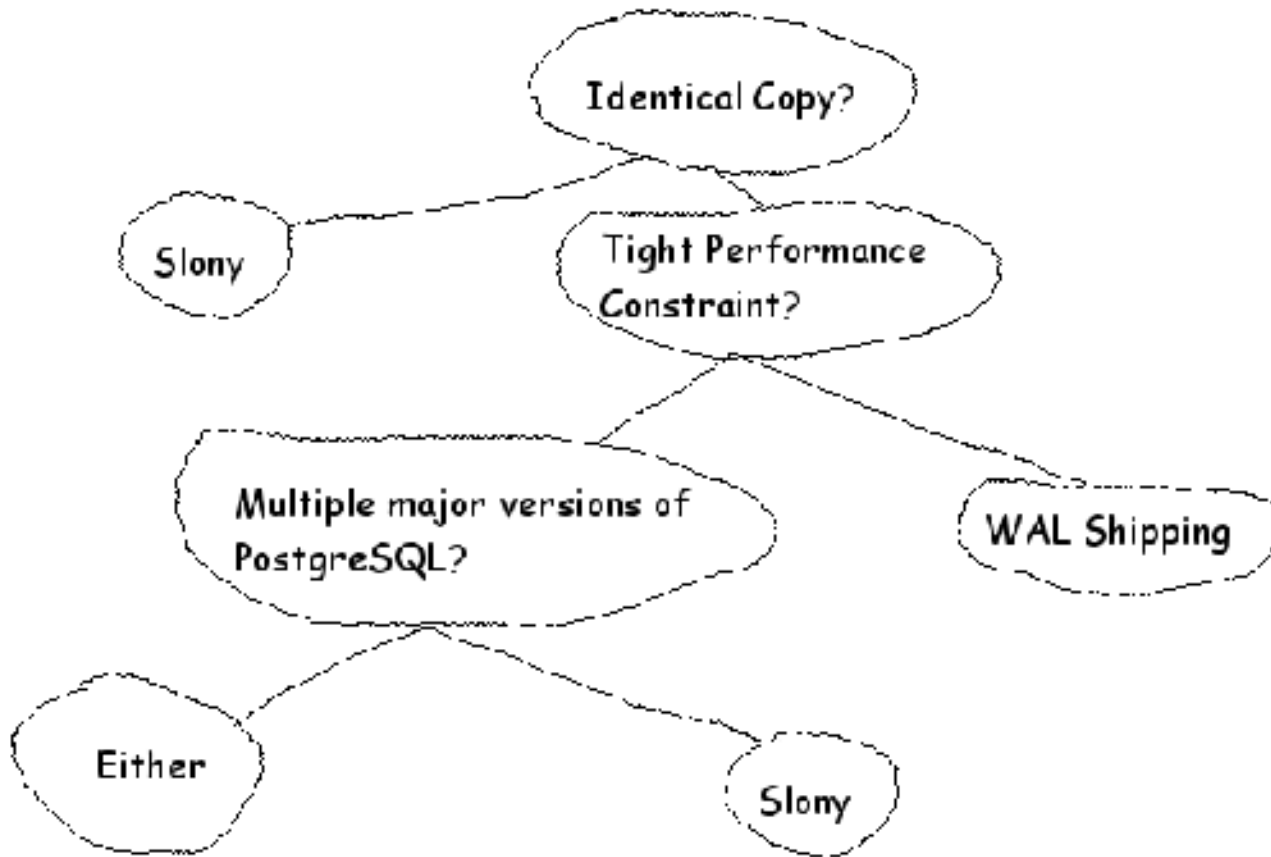

Steve Singer
ssinger_pg@sympatico.ca

About Steve

Over 10 Years of PostgreSQL

Maintainer of Slony-I replication engine

Occasional patch reviewer and contributor

OpenStreetMap Contributor (stevens)

<http://scanningpages.wordpress.com>

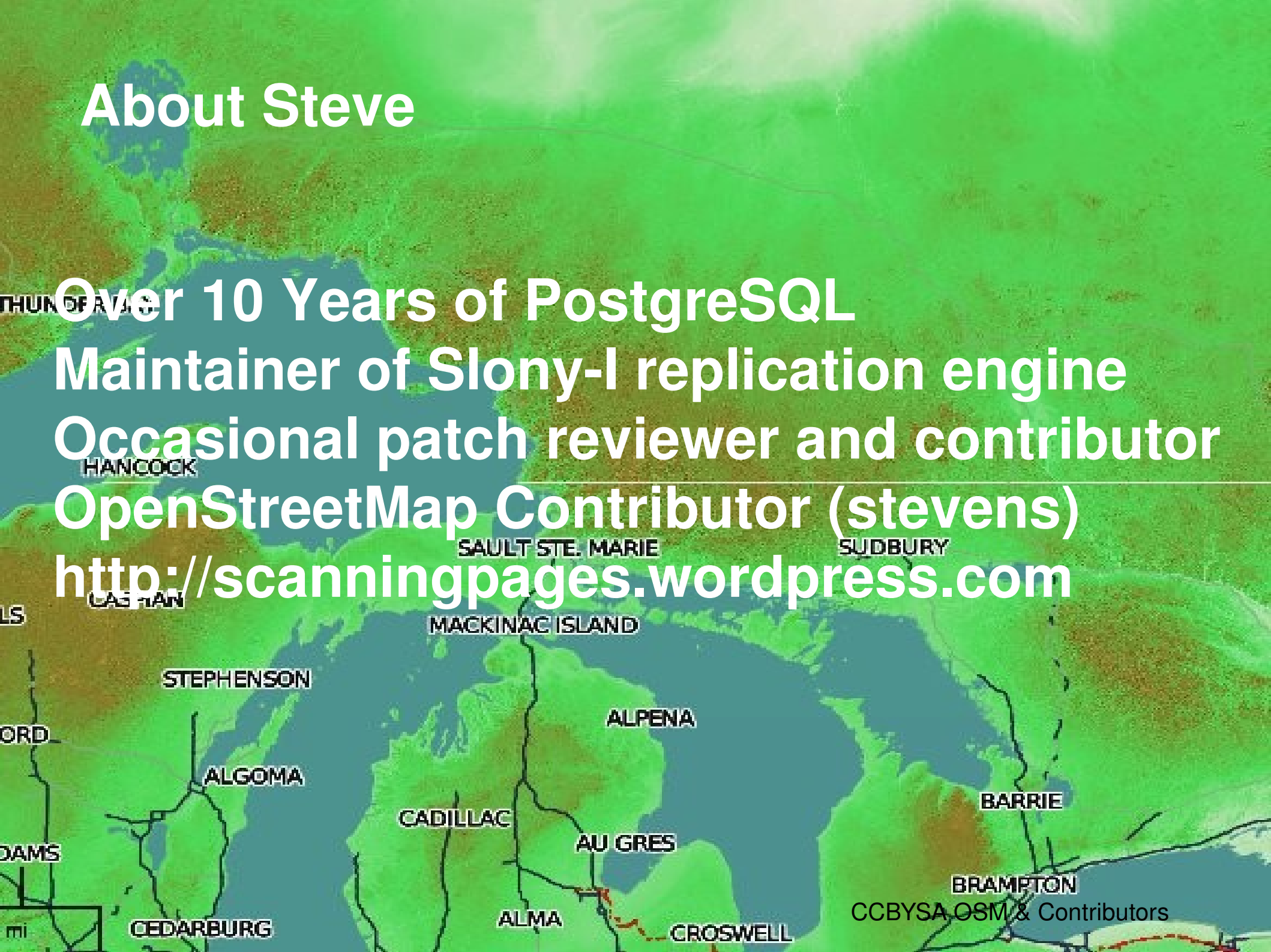

Topics For Today

(or at least the next 20 minutes)

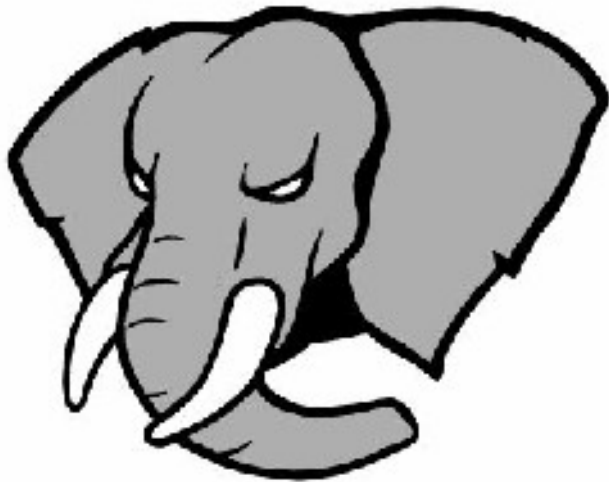

Slony-I



Streaming Replication

Why Replicate ?



Failover



Load Balancing



Step 1

Map out the problem you want to solve

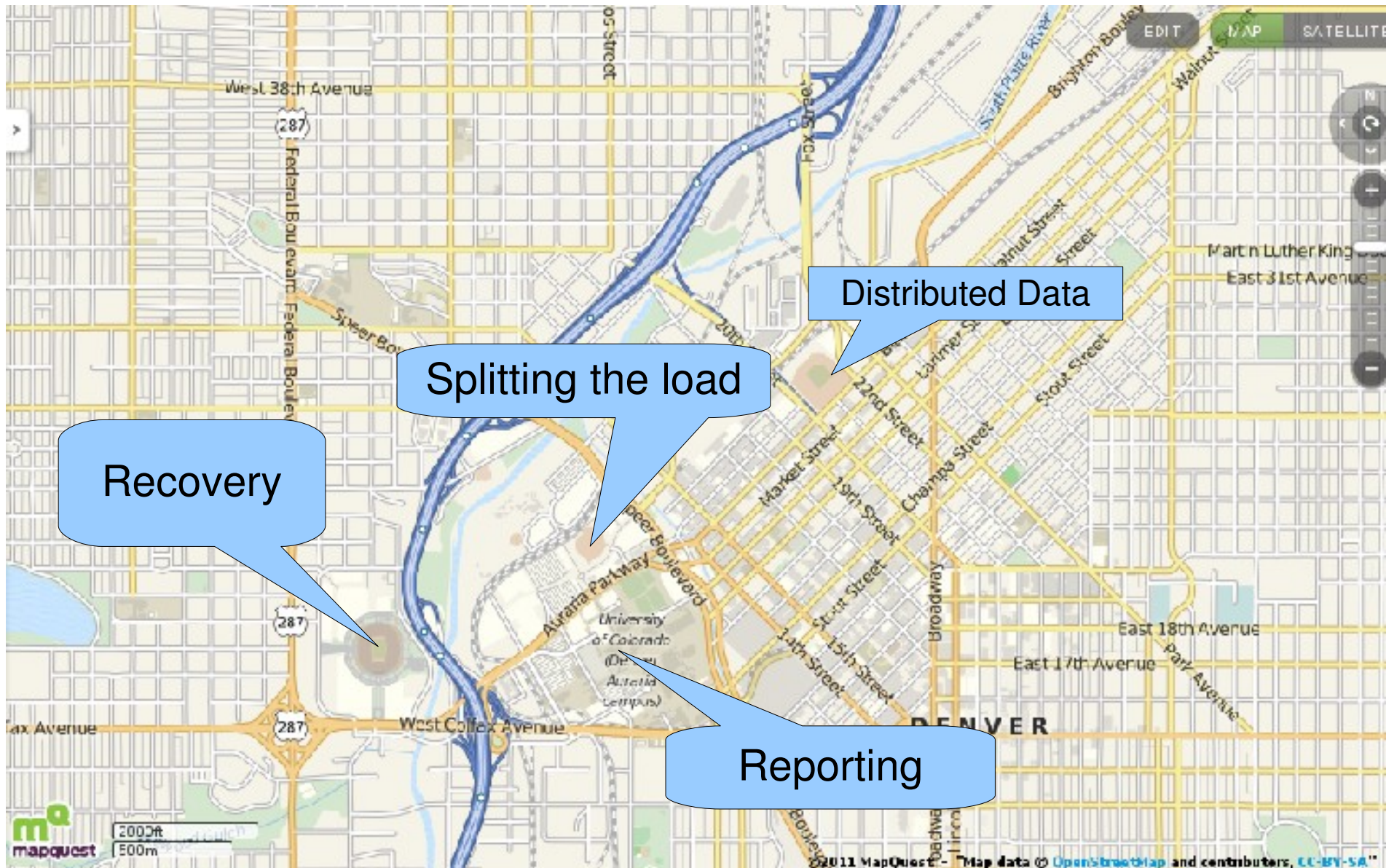

Do I need disaster recovery ?

Do I need to replicate my entire database ?

Am I replicating between multiple versions of PostGIS ?

Do I need to load balance big spatial queries ?

Do I need to spread my write load ?

Replication Patterns

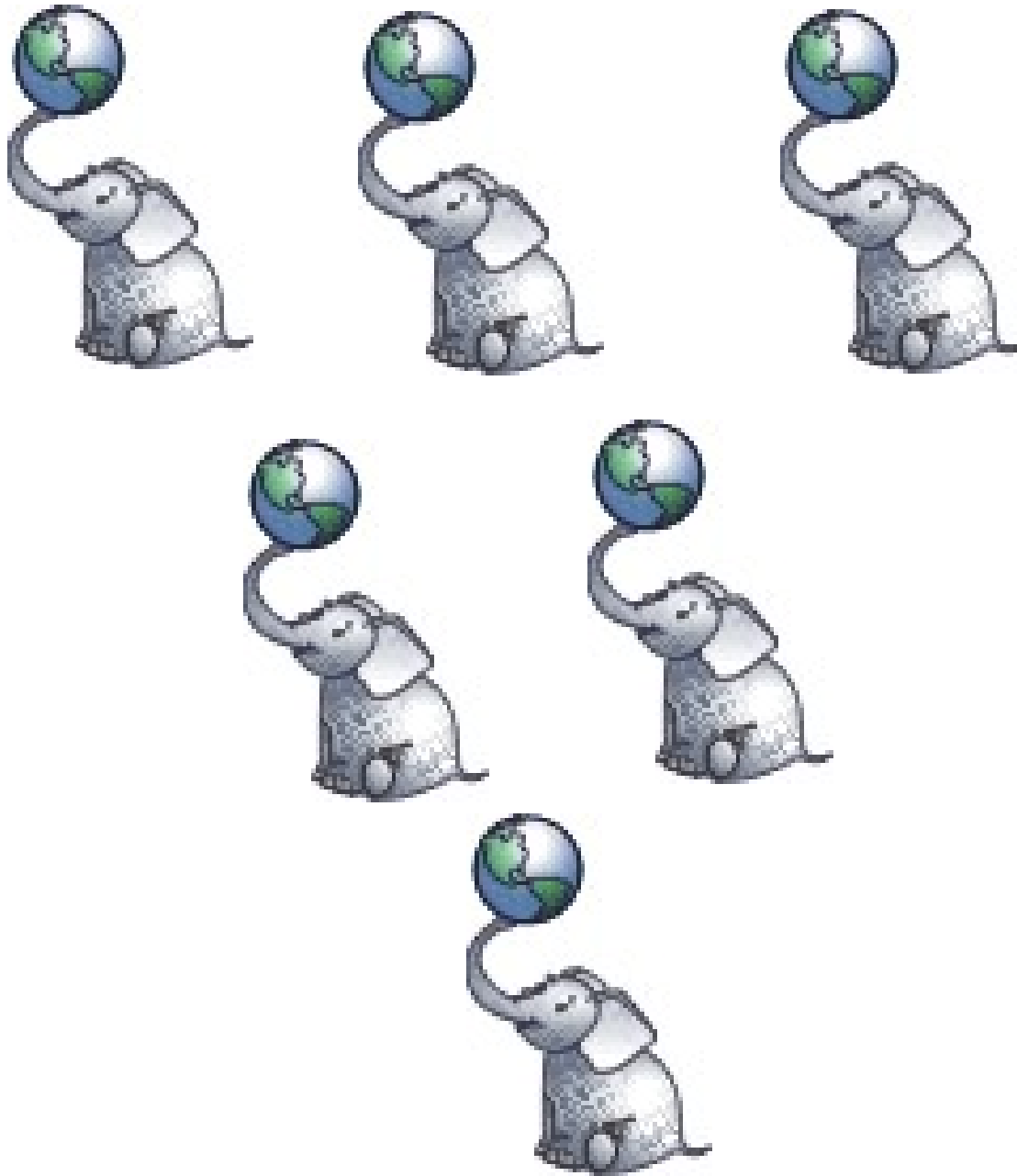

Load Balanced Reads

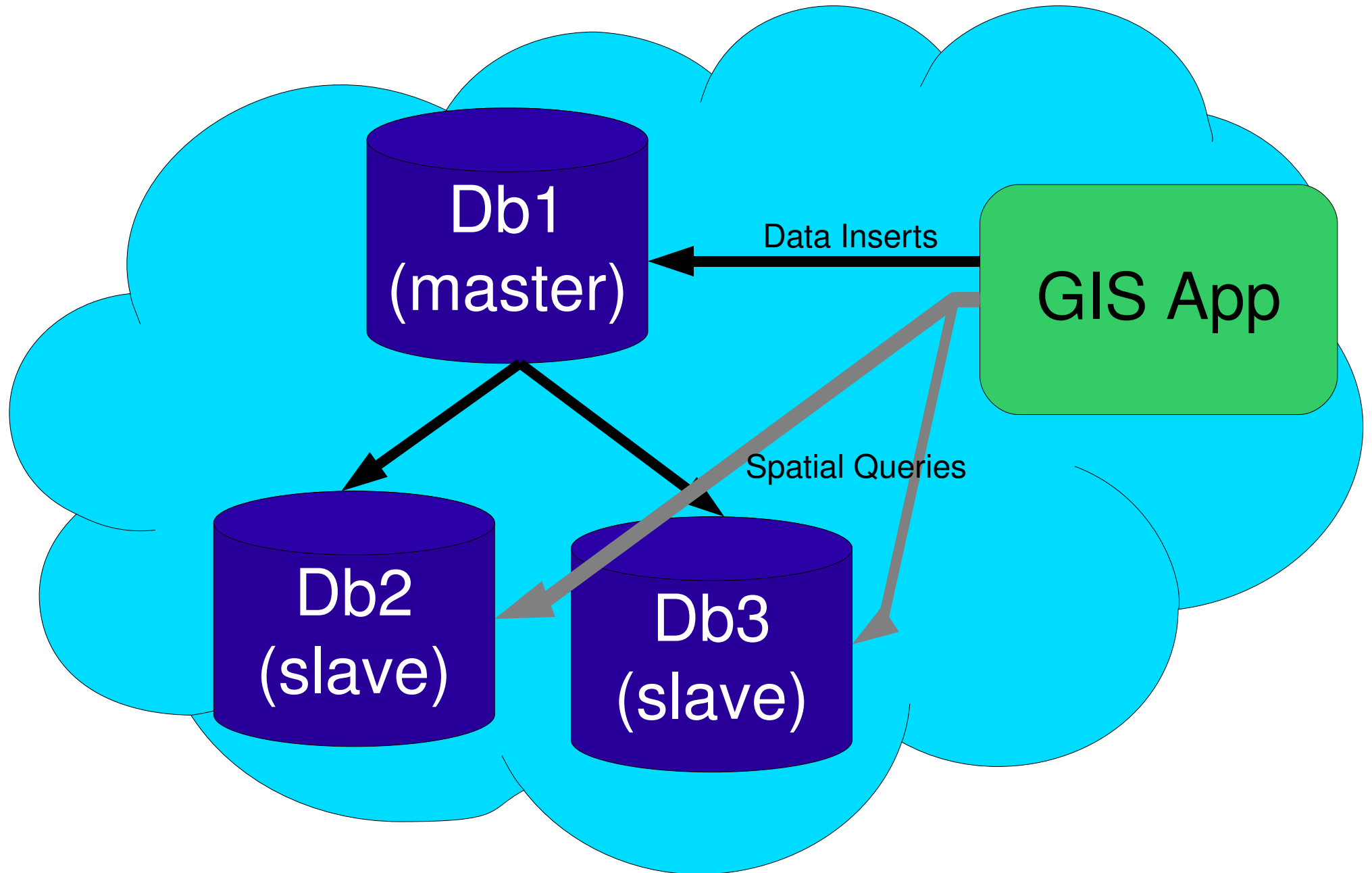

Split Applications

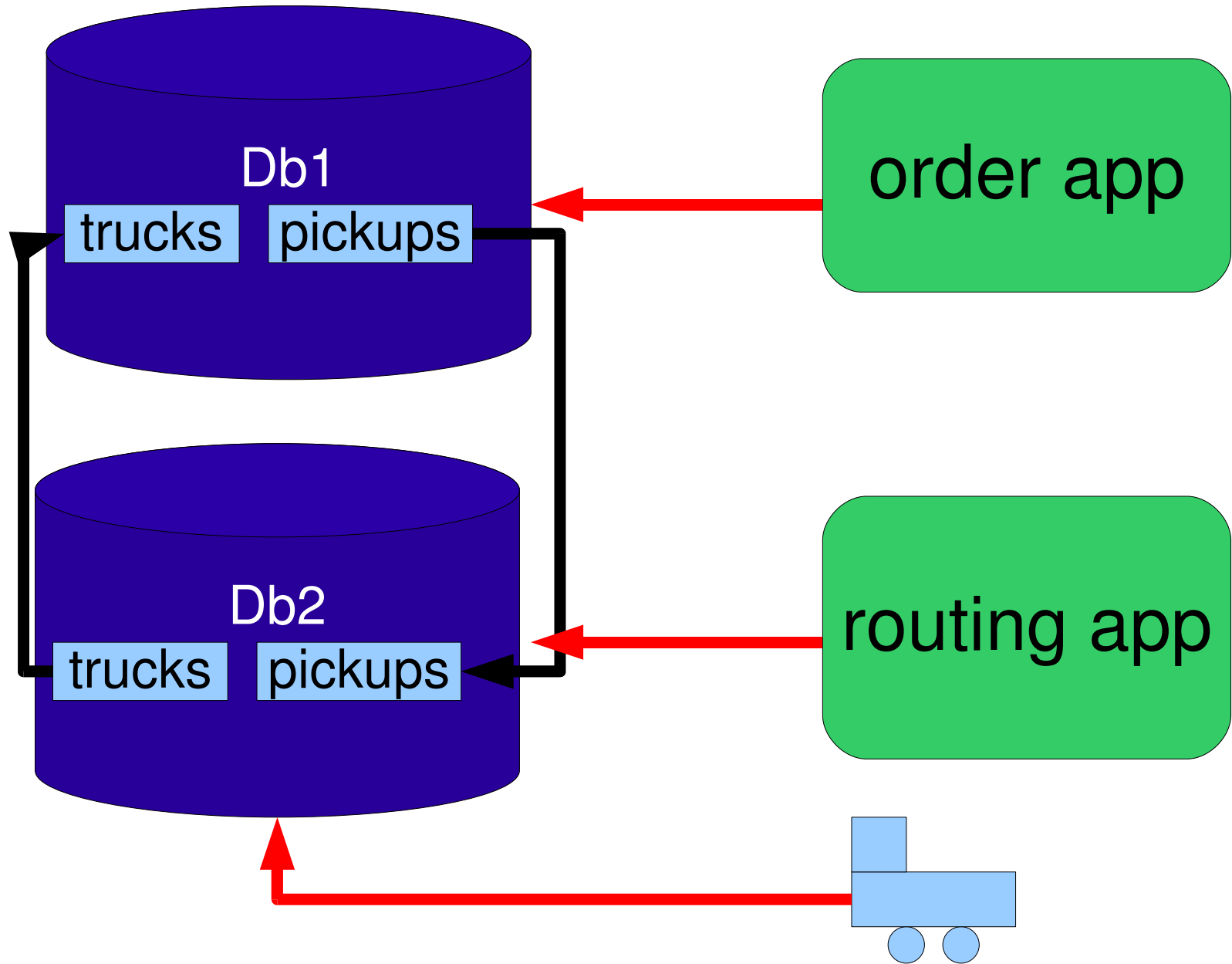

Map Rendering

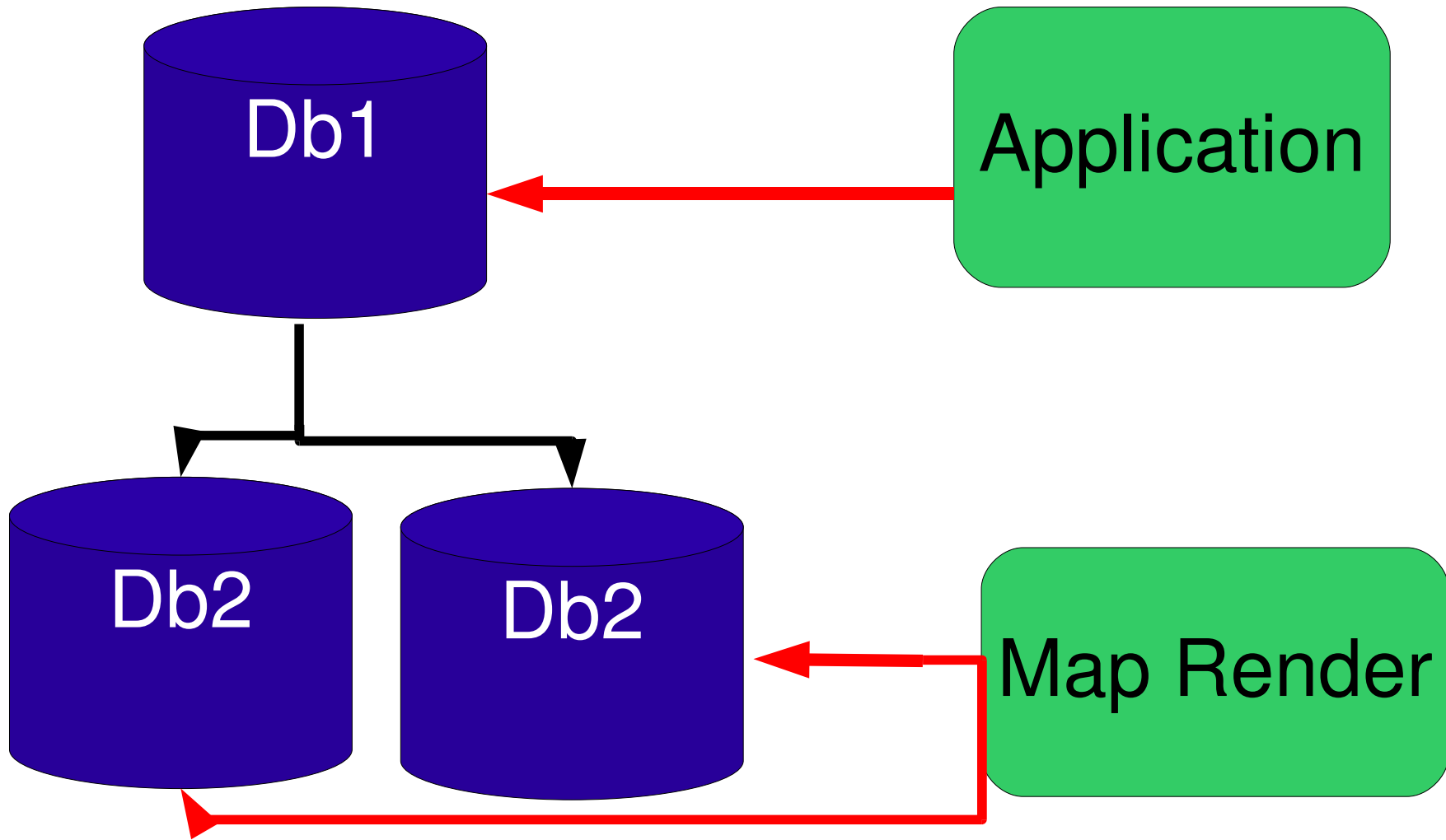

What is important to you

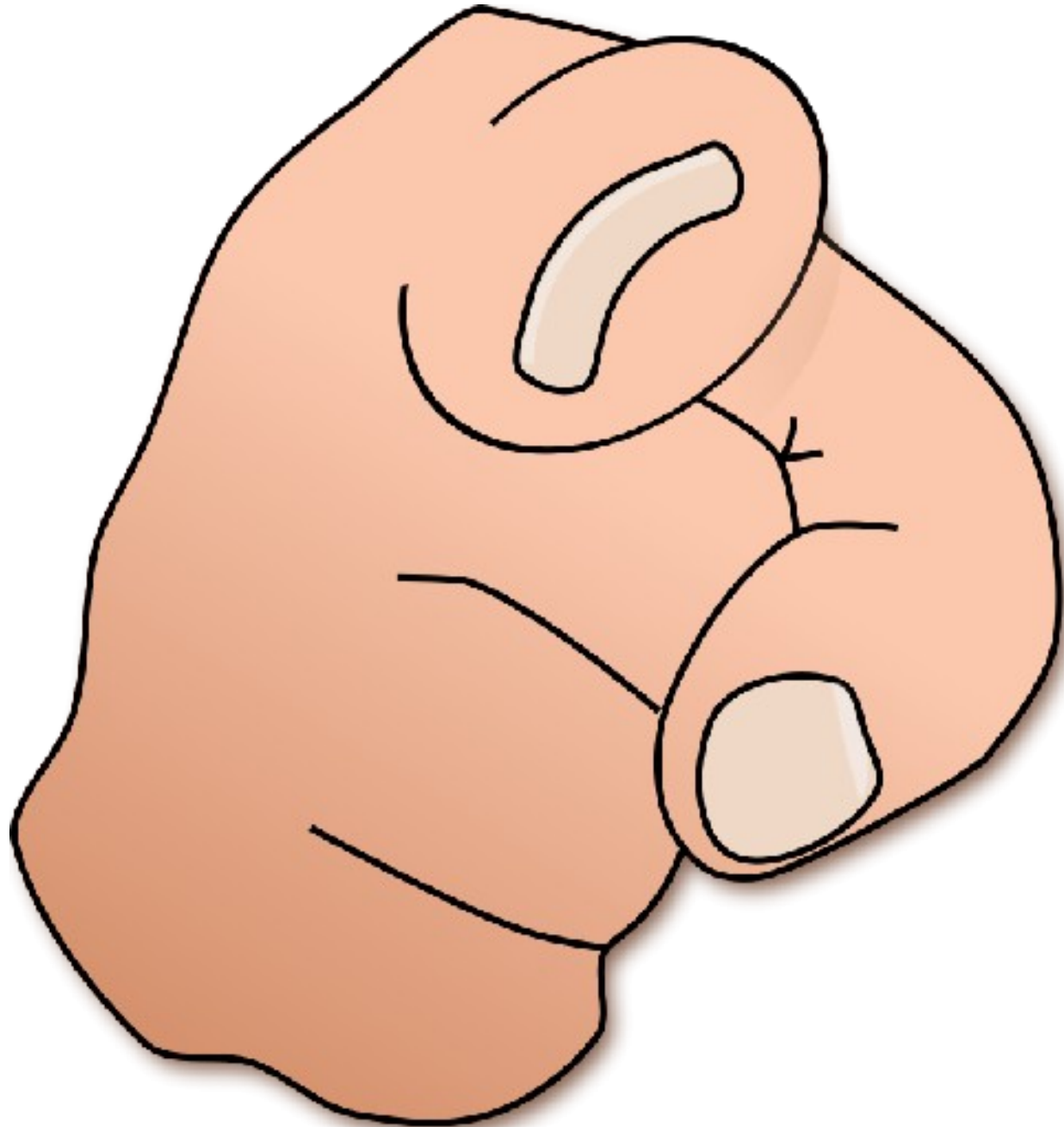

Slony-I

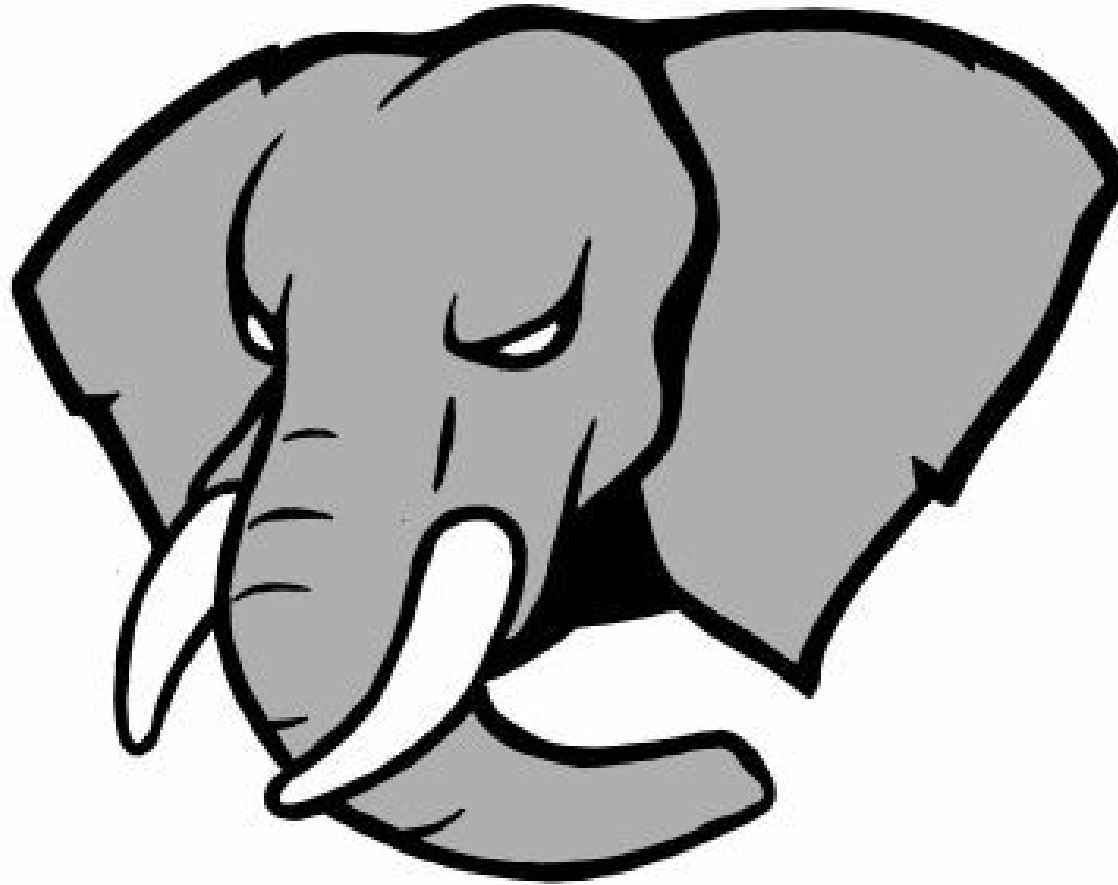

<http://www.slony.info>

Slony-I

Key Features

Multiple Origin nodes (for different tables)

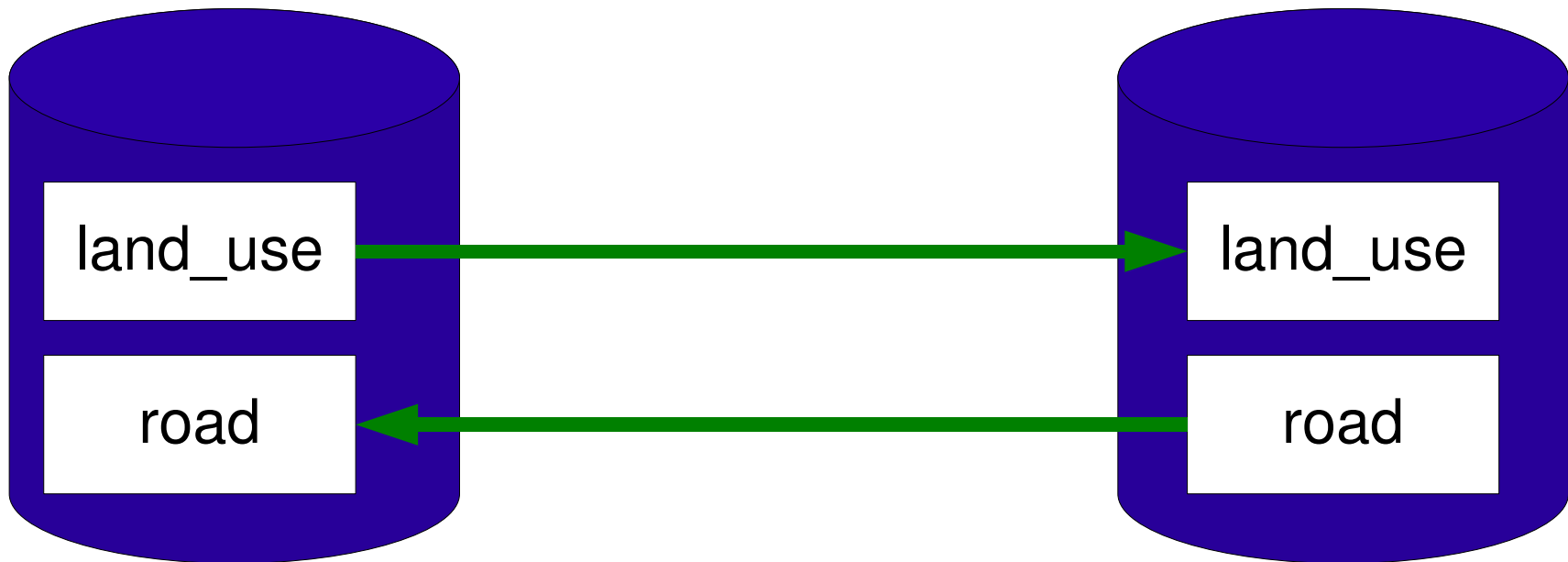

Cascaded Replication

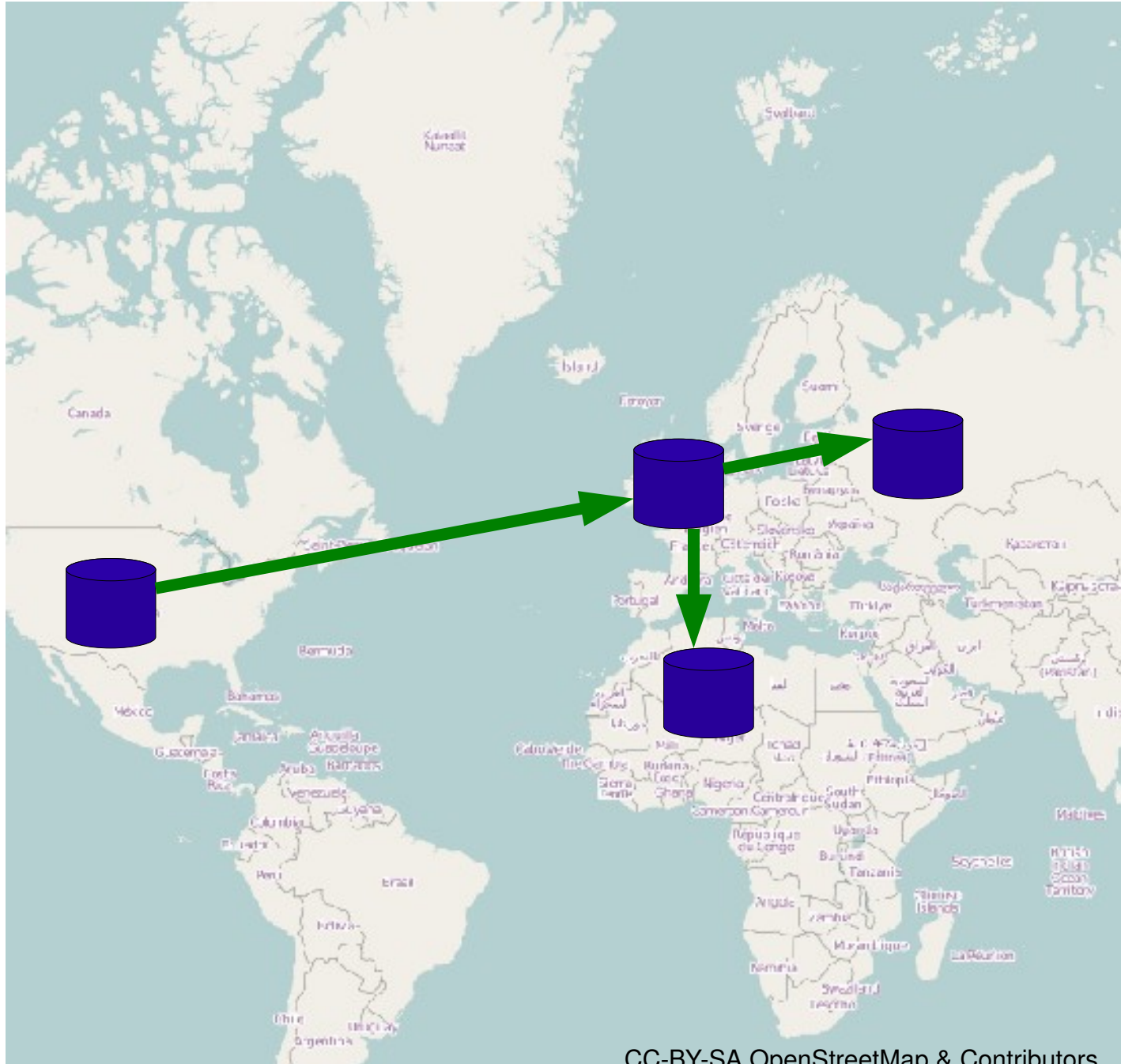

Triggers On Replicas

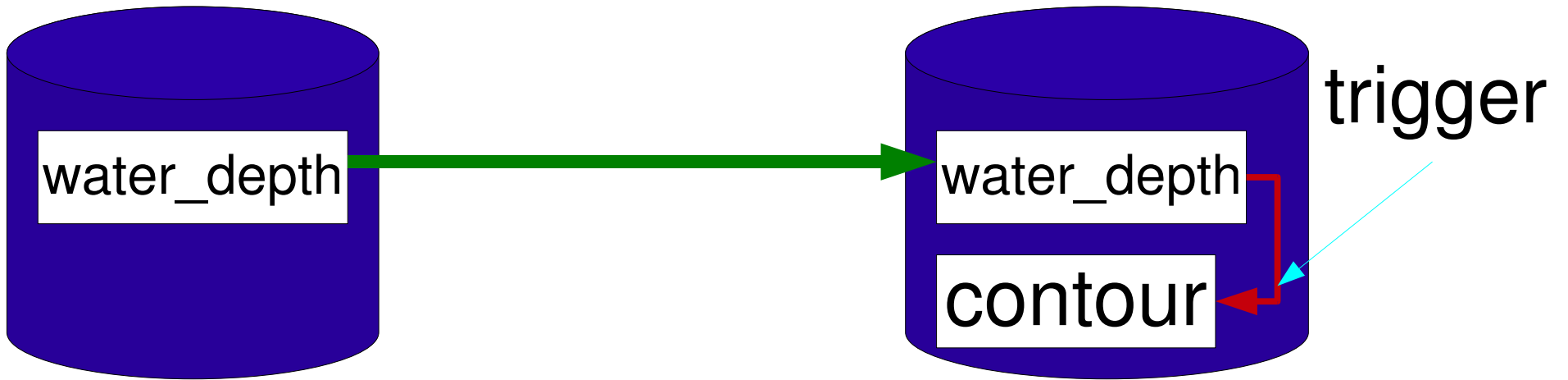

Slony Components



Slonik

<http://www.flickr.com/photos/ikkoskinen/4046500800/sizes//>

Slony Components

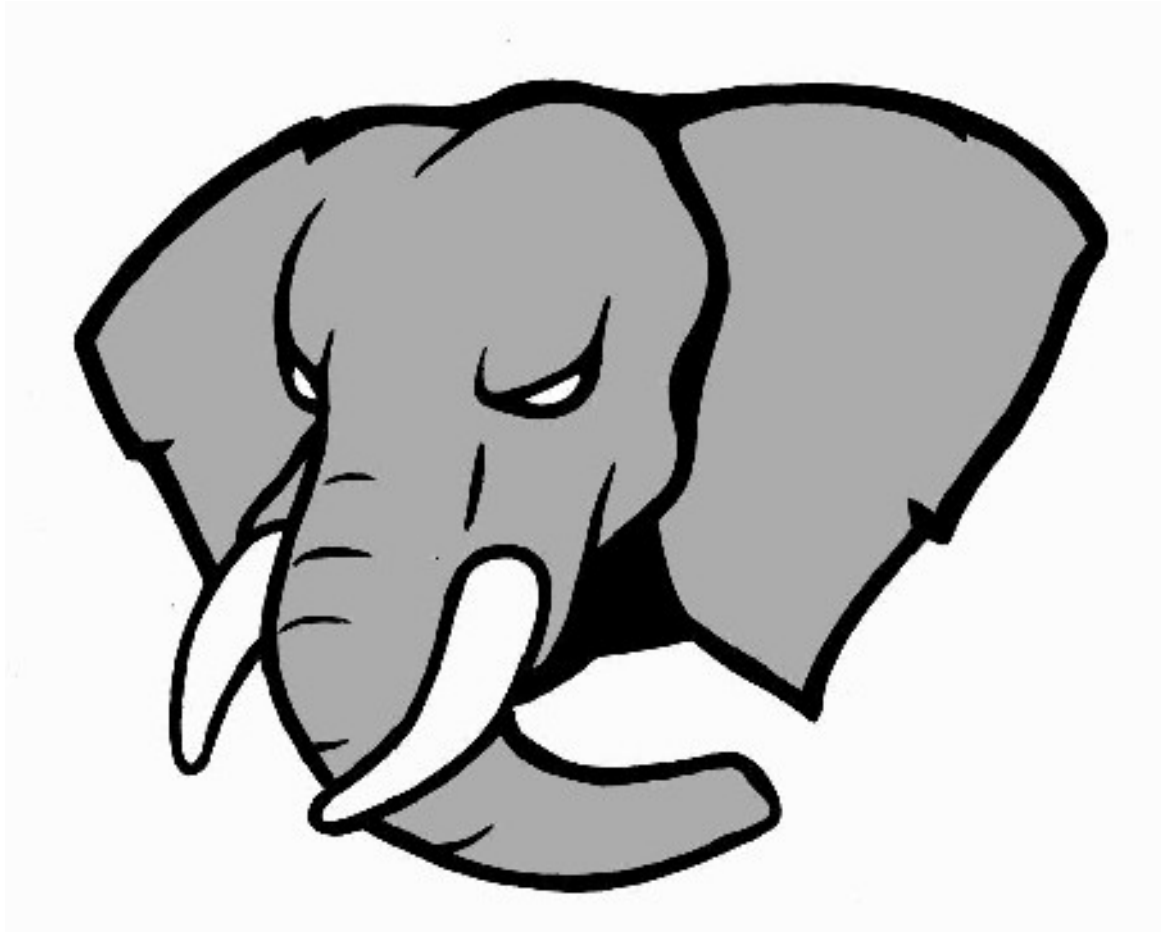

Slon (replication daemon)

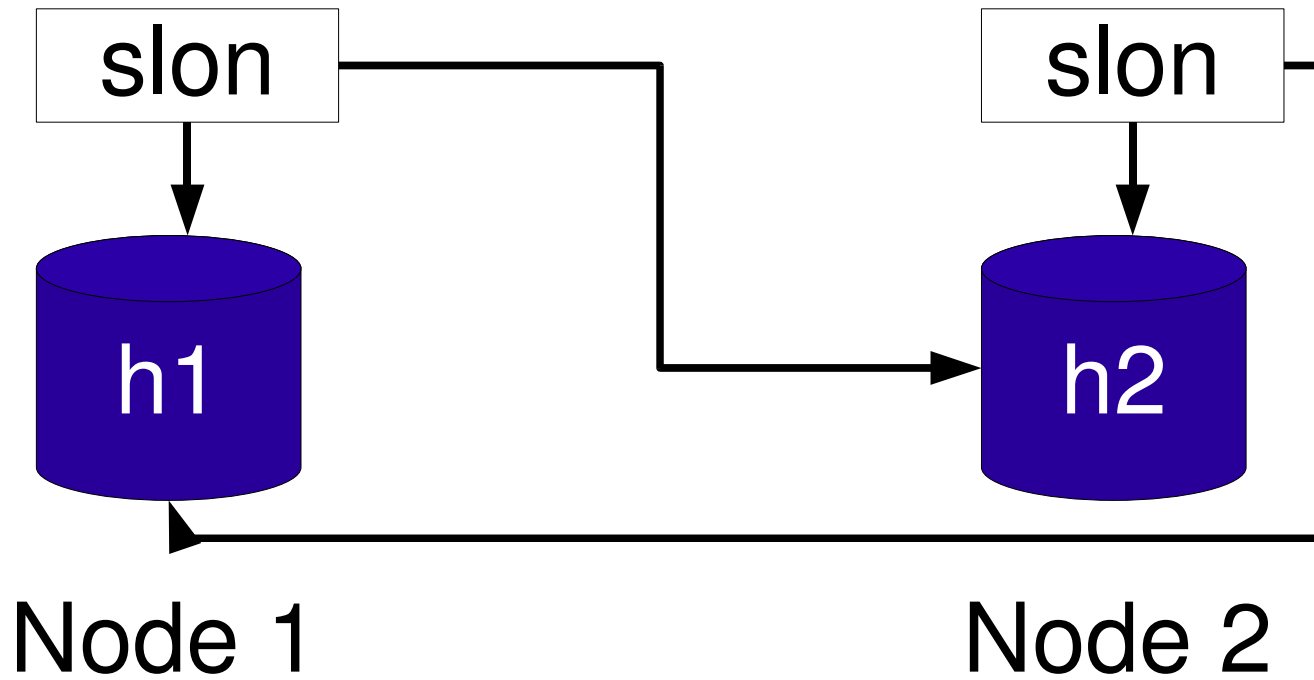

PostGIS tips

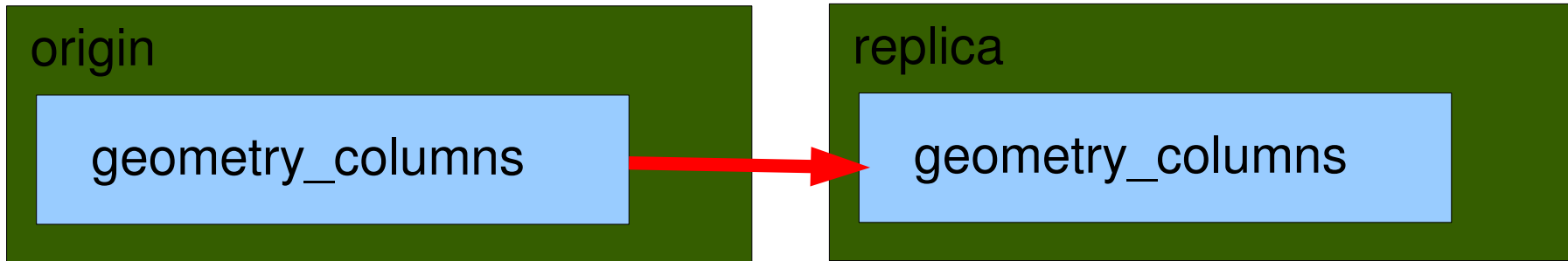

OR

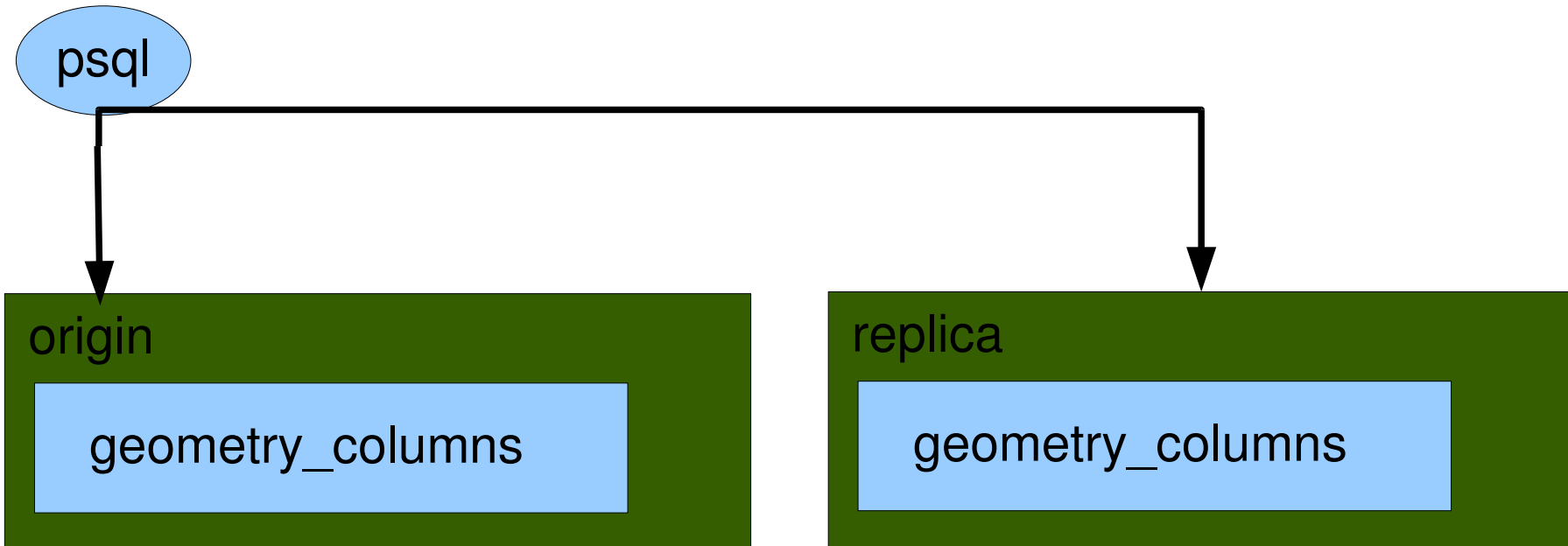

Slony Does not replicate DDL

AddGeometryColumns() must be run on each replica

The EXECUTE SCRIPT command can help

What does replicating geometry_columns gains you?
(pain?)

Limitations

DDL Changes are not automatically replicated

10-30% performance impact

BLOBS are not supported

Easy to shoot yourself in the foot

Streaming Replication



PostgreSQL *Write Ahead Log* (WAL)

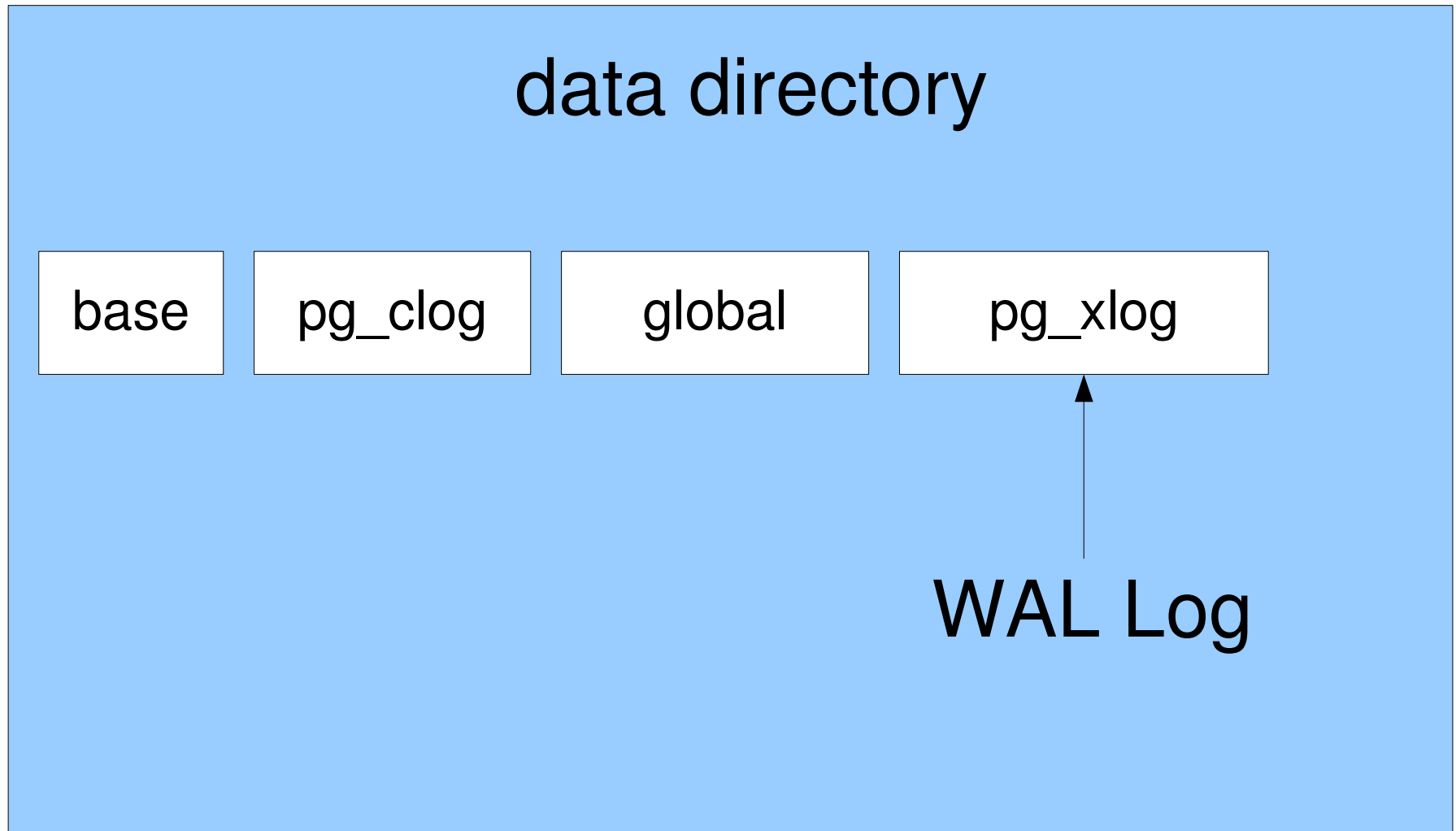

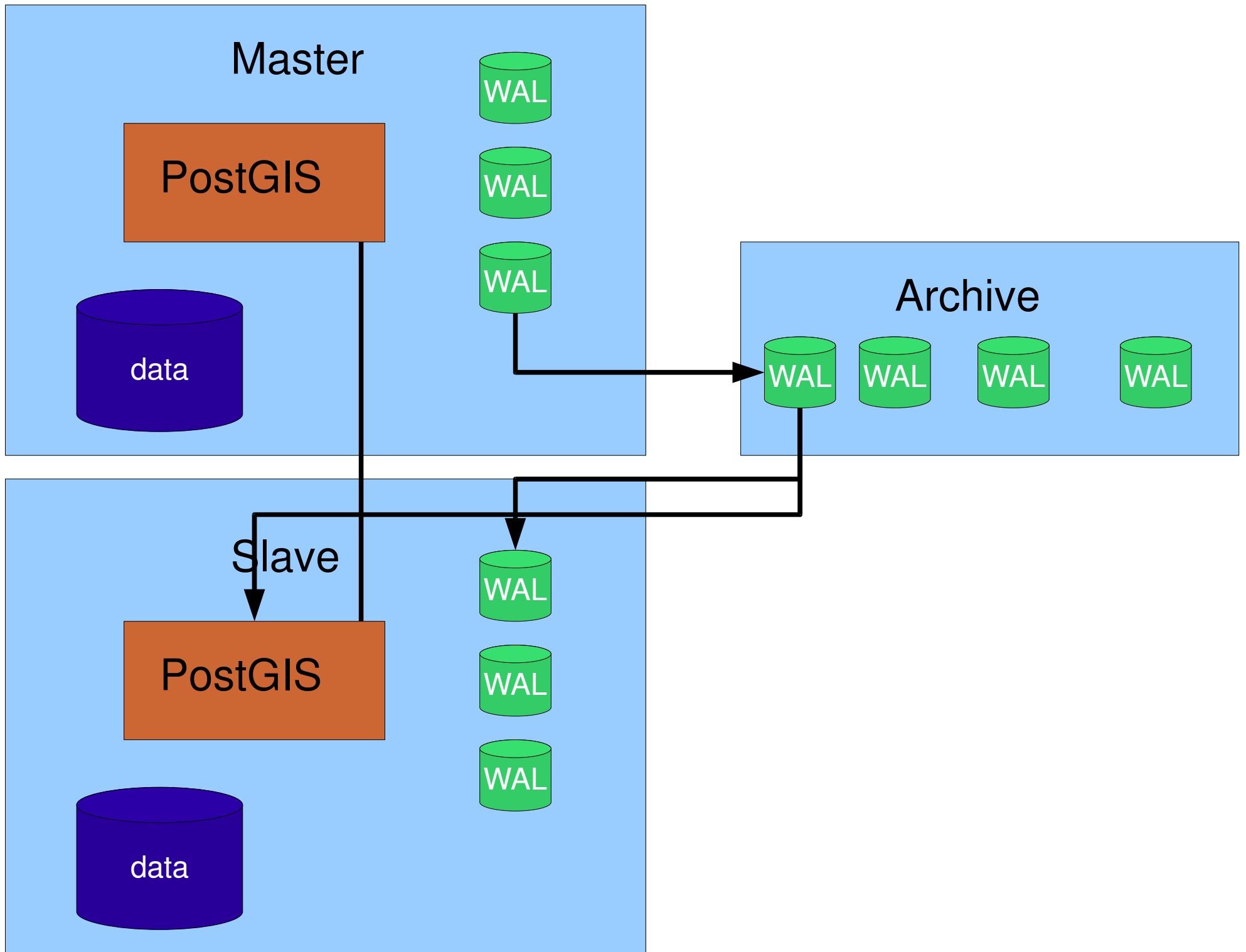

Streaming Replication

Key Features

Easy To Setup

Streaming Replication

Key Features

All SQL is replicated (DDL,BLOBS,...)

Streaming Replication

Key Features

Limited Performance Impacts

Streaming Replication Limitations

No new tables or data allowed on the slave

Temporary tables are not allowed on slaves

Versions of PostgreSQL, PostGIS must match

Long running queries (on the slave) get aborted or stop replication

Steps To Setup Streaming Replication

QRH

1. wal_level=hot_standby
2. archive_command (set)
3. Perform a base backup
4. Setup pg_hba.conf
5. Setup recovery.conf
6. hot_standby=on

Questions ?

Steve Singer

<http://scanningpages.wordpress.com>

ssinger_pg@sympatico.ca

IRC: stevenSn

CC-BY-SA